

APPENDIX 6
10440 INTERIOR SIGNAGE REQUIREMENTS



SHIPPENSBURG UNIVERSITY
INTERIOR SIGN SPECIFICATIONS 2022

OFFICIAL LOGO SUBMISSION:

PRIOR APPROVALS ARE NEEDED TO USE UNIVERSITY OFFICIAL "SHIP" OR "SU" LOGOS. CONTACT UNIVERSITY COMMUNICATIONS & MARKETING DEPARTMENT – BRANDING DIVISION FOR APPROVALS.

SIGN DESIGN:

SIGNAGE STANDARDS (U.N.O.):
SHIPPENSBURG UNIVERSITY protocol for all Academic Buildings:
Back plate w/coordinating face plate design & radius corners;
Tactile Grade II, Raised 1/32”H. w/Braille Plate;
Font style: Helvetica–Medium;Text Height, min. 1/2” or as shown.
Sign color: CHARCOAL GRAY
Text color: BRIGHT WHITE

MOUNTING METHODS:

TYPICAL:
(3) continuous strips of double–sided tape applied to back.
ON BLOCK or BRICK: Use silicon with double–sided tape.
ON GLASS: Use clear double–sided tape for mounting.

SIGN INSTALLATION:

- 1– WIPE WALL SURFACE, FREE OF DIRT, DUST OR FILM ON WALL.
- 2– USE LEVEL TO PLACE SIGN STRAIGHT HORIZONTALLY.
- 3– PLACE CENTER OF SIGN @ 9” FROM FRAME (LATCH SIDE) HORIZONTAL WITH THE TOP OF SIGN @ 60”AFF–VERTICALLY.
- 4– ALLOW 1/2” CLR SPACE BETWEEN SIGNS, VERT. & HORIZ. (MAX–HEIGHT= 60” AND MIN–HEIGHT=48” ABOVE FLOOR).







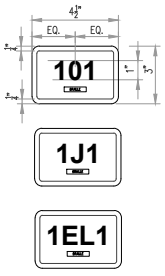
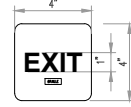

TYPICAL SIGN PLATE & TEXT COLORS

STUDENT SERVICES: Silver #304 sign w/Blue #501 text.
ACADEMIC BUILDINGS: Charcoal Grey #307 sign w/bright white #204 text.
RESIDENT HALLS: Silver #304 sign w/Blue #501 text.
BRANDING: Pearl Gray #306; Marine blue #502; Red #601;White #204.

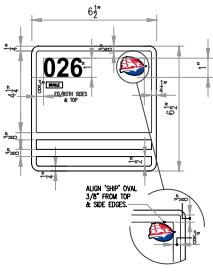
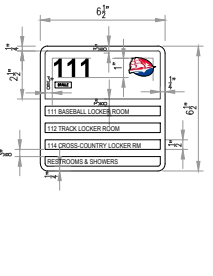
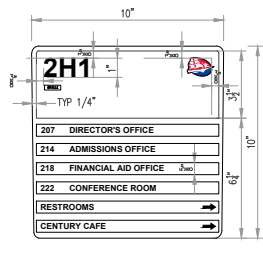
APPENDIX 6 10440 INTERIOR SIGNAGE REQUIREMENTS

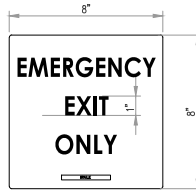
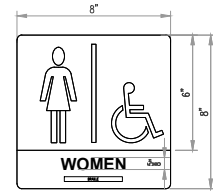
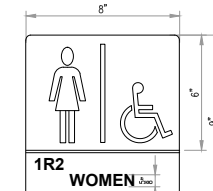
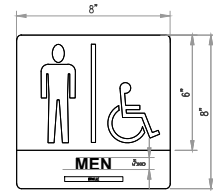
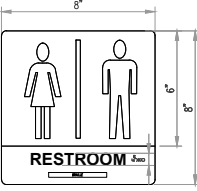
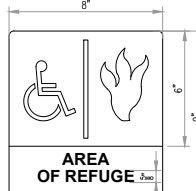
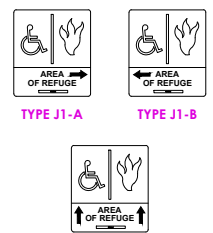
6-1-22

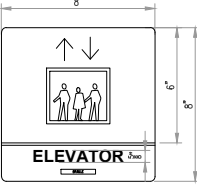
SHIPPENSBURG UNIVERSITY - 2022 Sign Package (L)

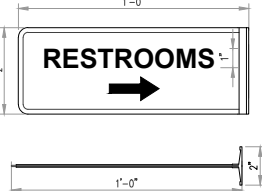
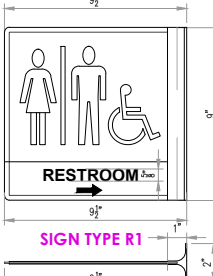
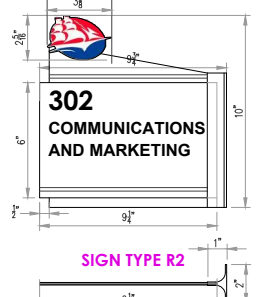
<p>A</p> <p>ROOM NUMBER PLATE 4.5x3 - w/TACTILE & BRAILLE</p>  <p>SIGN TYPE A</p> <p>4.5"x3" w/ 1/8" backer plate (leaving 1/4" reveal) 4"x2.5"x1/16" face panel w/raised Text & Braille; Text 1"H., Centered Horizontally.</p>	<p>A1</p> <p>SMALL 'EXIT' PLATE 4x4 - w/TACTILE & BRAILLE</p>  <p>SIGN TYPE A1 4"x4"x 1/8" tactile sign w/ raised Text & Braille; Text Height: 1" H., Centered Horizontally.</p> <p>ELEVATOR ID NUMBER PLATE 4x4 - TACTILE NO.</p>  <p>ELEVATOR ID NUMBER PLATE</p> <p>4"x4"x 1/8" acrylic plate w/ raised Text (No Braille); Text Height: 2"H., Centered Horizontally.</p>	<p>B</p> <p>CLASSROOM or OFFICE (2)-SLOT 6.5x6.5-1/2" INSERTS, TACTILE, BRAILLE & LOGO</p>  <p>SIGN TYPE B SIGN TYPE B* (Includes 'Ship' Logo)</p> <p>6.5"x6.5" ADA sign x 1/8" acrylic backer (leaving 1/4" reveal) 6"x4.25"x1/16" face panel w/raised Text & Braille and (2)-0.5"H x 6" W window slots at bottom; *Logo included @ top right corner.</p>	<p>C</p> <p>OFFICE (4)-SLOT 6.5x6.5 - 1/2" INSERTS, TACTILE, BRAILLE & 1" high LOGO</p>  <p>SIGN TYPE C SIGN TYPE C* (Includes 'Ship' Logo)</p> <p>6.5"x6.5" ADA sign x 1/8" acrylic backer (leaving 1/4" reveal) 6"x4.25"x1/16" face panel w/raised Text & Braille and (4)-0.5"H x 6" W window slots at bottom; *Logo included @ top right corner.</p>	<p>D</p> <p>10"x10" MEDIUM DIRECTORY (6)-SLOT INSERTS w/TACTILE, BRAILLE & 1" high LOGO</p>  <p>SIGN TYPE D SIGN TYPE D* (Includes 'Ship' Logo)</p> <p>10"x10"x1/8" tactile acrylic backer (leaving 1/4" reveal) 9.5"x3.5"x1/16" face panel w/raised Text & Braille and (6)-0.5"H x 6" W window slots at bottom; *Logo included @ top right corner.</p>
<p>E4</p> <p>ROOM NO. & NAME: 8.5x5.5 - w/BRAILLE ROOM NO.: (0.75") H. TACTILE ROOM NAME: (0.625") H. TACTILE</p>  <p>SIGN TYPE E4 SIGN TYPE E4* (Includes 'Ship' Logo)</p> <p>8.5"x5.5"x 1/8" backer plate (leaving 1/4" reveal) 8"x5"x1/16" face panel w/raised Text, Arrows & Braille; Room Number 3/4" H., Top left justified. Room Name 5/8" H., Center justified. *Logo included @ top right corner.</p>	<p>E5</p> <p>'EMERGENCY EXIT ONLY' 8x8 - ISA TACTILE & BRAILLE</p>  <p>SIGN TYPE E5</p> <p>8"x8"x1/8" tactile plate w/ raised text & Braille Text: "EMERGENCY EXIT ONLY" centered horizontally. Text Height: (3) Lines @ 1" H.; (4) Lines @ 3/4" H.</p>	<p>F</p> <p>WOMEN'S ADA RESTROOM PICTOGRAM w/ROOM NUMBER 8x8 - ISA TACTILE & BRAILLE</p>  <p>SIGN TYPE F</p> <p>8"x8"x1/8" tactile plate w/ raised Pictogram, Braille & Text: "WOMEN"; Text Height: 5/8" H.</p>	<p>F1</p> <p>WOMEN'S ADA RESTROOM PICTOGRAM w/ROOM NUMBER 8x9 - ISA TACTILE & BRAILLE</p>  <p>SIGN TYPE F1 Option w/Rm #</p> <p>8"x9"x1/8" tactile plate w/ raised Pictogram, Braille & Text: "WOMEN"; Text Height: 5/8" H.</p>	<p>G</p> <p>MEN'S ADA RESTROOM PICTOGRAM 8x8 - ISA TACTILE & BRAILLE</p>  <p>SIGN TYPE G</p> <p>8"x8"x1/8" tactile plate w/ raised Pictogram, Braille & Text: "MEN"; Text Height: 5/8" H.</p>
<p>H2</p> <p>UNISEX RESTROOM PICTOGRAM 8x8 - (NON-ADA) ISA TACTILE & BRAILLE</p>  <p>SIGN TYPE H2</p> <p>8"x8"x1/8" tactile plate w/ raised Pictogram, Braille & Text: "RESTROOM"; Text Height: 5/8" H.</p>	<p>J</p> <p>'AREA OF REFUGE' - PICTOGRAM 8x9 - w/TACTILE & BRAILLE</p>  <p>SIGN TYPE J</p> <p>8"x9"x1/8" tactile plate w/ raised Pictogram, Braille & Text: "AREA OF REFUGE"; Text Height: 5/8" H.</p>	<p>J1</p> <p>'AREA OF REFUGE' - PICTOGRAM w/ARROWS 8x9 - w/TACTILE & BRAILLE</p>  <p>SIGN TYPE J1-C</p> <p>8"x9"x1/8" tactile plate w/ raised Pictogram, Braille & Text: "AREA OF REFUGE" w/Arrows; Text Height: 5/8" H.</p>	<p>K</p> <p>ADA ACCESSIBLE 'EXIT' PICTOGRAM 8x8 - ISA TACTILE & BRAILLE</p>  <p>SIGN TYPE K</p> <p>8"x8"x1/8" tactile plate w/ raised Pictogram, Braille & Text: "EXIT"; Text Height: 5/8" H.</p>	<p>K1-A</p> <p>ADA ACCESSIBLE PICTOGRAM 'EMERGENCY EXIT' w/DIRECTIONAL ARROW 8x9 - ISA TACTILE & BRAILLE</p>  <p>SIGN TYPE K1-A</p> <p>8"x9"x1/8" tactile plate w/ raised Pictogram, Braille & Text: "EMERGENCY EXIT" w/Arrow; Text Height: 5/8" H.</p>
<p>P</p> <p>'ELEVATOR' - PICTOGRAM 8x8 - w/TACTILE & BRAILLE</p>  <p>SIGN TYPE P</p> <p>8"x8"x1/8" tactile plate w/ raised Pictogram, Braille & Text: "ELEVATOR"; Text Height: 5/8" H.</p>	<p>Q-Q2</p> <p>ADA 'ALL GENDER RESTROOM' PICTOGRAM - OPTIONS 8x9 - ISA TACTILE & BRAILLE</p>  <p>SIGN TYPE Q</p> <p>8"x9"x1/8" tactile plate w/ raised Pictogram, Braille & Text: "(varies)"; Text Height: 5/8" H.</p>	<p>R</p> <p>'RESTROOMS' Wall-Mounted FLAG SIGN (12 x 4.5 x 1/8") w/ARROW DOUBLE-SIDED Face Plates</p>  <p>SIGN TYPE R</p> <p>FLANGE MOUNT SIGN- Double-sided 4.5"x12"x1/8" acrylic backer (leaving 1/4" reveal) 4"x11.25"x1/16" face panel on BOTH SIDES w/ raised Text & Arrow (no Braille) with black flange bracket for mounting to wall.</p>	<p>R1</p> <p>UNISEX 'RESTROOM' Wall-Mounted FLAG SIGN w/ARROW 9.5x9x1/8" DOUBLE-SIDED Face Plates</p>  <p>SIGN TYPE R1</p> <p>FLANGE MOUNT SIGN- Double-sided 9"x9.5"x1/8" acrylic backer (leaving 1/4" reveal) 8.5"x8.75"x1/16" face panel on BOTH SIDES w/ raised Pictogram & Text (no Braille) with black flange bracket for mounting to wall.</p>	<p>R2</p> <p>'SHIP' DEPT FLAG WAYFINDING SIGN DBL-Sided w/Ship' Logo +2" high 9.75x10 w/WALL-MOUNTED BRACKET</p>  <p>SIGN TYPE R2</p> <p>10"x9.75"W. Double-Sided Projecting Sign w/ship bracket for mounting. White text on blue panel. Red vinyl accents; Pearl Gray backer piece w/raised 3-color logo shape at top. Logo detail applied as decal.</p>

SHIPPENSBURG UNIVERSITY - 2022 Sign Package (R)

D1 12"x12" Over-Lay WAYFINDING DIRECTORY (8-SLOTS) (Printed PVC Option)

SIGN TYPE D1 - Overlay
SIGN TYPE D1* (Includes 'Ship' Logo)

WAYFINDING DIRECTORIES
12x12 (or 10x10) x 1/4" PVC Directory Sign
Printed as a decal applied to face of black panel.

E ROOM NUMBER PLATE
6.5x2.5 - w/TACTILE & BRAILLE

SIGN TYPE E
SIGN TYPE E* (Included 'Ship' Logo)

6.5"x2.5" x 1/8" backer plate (leaving 1/4" reveal)
6"x2"x1/16" face panel w/raised Text & Braille;
Text height & location varies; Logo optional.

E1 ROOM NO. & NAME
8.5x2.5 - w/TACTILE & BRAILLE

SIGN TYPE E1

8.5"x2.5" x 1/8" backer plate (leaving 1/4" reveal)
8"x2"x1/16" face panel w/raised Text & Braille;
Room Number 5/8" H., Left justified.
Room Name (same row) 5/8" H., Right justified.
Or Text 5/8" H., Centered Horizontally.

E2 ROOM NAME & NO. PLATE (w/ARROW)
8.5x3.5 - w/TACTILE, BRAILLE

SIGN TYPE E2

8.5"x3.5" x 1/8" backer plate (leaving 1/4" reveal)
8"x3"x1/16" face panel w/raised Text, Arrows & Braille;
Room Number 5/8" H., Top left justified.
Room Name 5/8" H., Center justified.
Or 2 rows 5/8" H., each as shown.

E3 ROOM NO. & NAME:
8.5x4.5 - w/BRAILLE

SIGN TYPE E3

8.5"x4.5" x 1/8" backer plate (leaving 1/4" reveal)
8"x4"x1/16" face panel w/raised Text, Arrows & Braille;
Room Number 3/4" H., Top left justified.
Room Name (rows 2 & 3) 5/8" H., Center justified.
Or all (3 rows) 5/8" H., as shown.

G1 MEN'S ADA RESTROOM PICTOGRAM
w/ROOM NUMBER
8x9 - ISA TACTILE & BRAILLE

SIGN TYPE G1
Option w/Rm #

8"x9" x 1/8" tactile plate w/ raised Pictogram, Braille & Text: "MEN"; Text Height: 5/8" H.
ROOM NUMBER to be included, as shown.

H UNISEX ADA 'RESTROOM' PICTOGRAM
8x8 - ISA TACTILE & BRAILLE

SIGN TYPE H

8"x8" x 1/8" tactile plate w/ raised Pictogram, Braille & Text: "RESTROOM"; Text Height: 5/8" H.

H1 UNISEX ADA 'RESTROOM' PICTOGRAM
w/ROOM NUMBER
8x9 - ISA TACTILE & BRAILLE

SIGN TYPE H1
Option w/Rm #

8"x9" x 1/8" tactile plate w/ raised Pictogram, Braille & Text: "RESTROOM"; Text Height: 5/8" H.
ROOM NUMBER to be included, as shown.

I Changeable INSERT FRAME (No Header)
11.5x9.5 - PAPER INSERT SLOT fits FULL-SHEET

SIGN TYPE I

9.5"x11.5" x 1/8" acrylic sign w/FULL INSERT
LARGE Window Slot to fit 8.5"x11" sheet.

I1 Changeable Message Frame
Small DIRECTORY w/HEADER
PAPER INSERT SLOT fits FULL-SHEET
11.5x13 - w/TACTILE & BRAILLE

SIGN TYPE I-1

13"x11.5" x 1/8" acrylic backer w/FULL INSERT & header
3.25"x11"x1/16" face panel w/raised text & Braille.
LARGE Window Slot to fit 8.5"x11" sheet.

L 'STAIRS' PICTOGRAM
8x8 - w/TACTILE & BRAILLE

SIGN TYPE L

8"x8" x 1/8" tactile plate w/ raised Pictogram, Braille & Text: "STAIRS"; Text Height: 3/8" H.

L1 'STAIRS' PICTOGRAM w/RM NO.
8x9 - w/TACTILE & BRAILLE

SIGN TYPE L1
Option w/Rm #

8"x9" x 1/8" tactile plate w/ raised Pictogram, Braille & Text: "STAIRS"; Text Height: 5/8" H.
ROOM NUMBER to be included, as shown.

L2 'EM EXIT STAIRS' PICTOGRAM
w/ROOM NUMBER
8x10 - w/TACTILE & BRAILLE

SIGN TYPE L2
Option w/Rm #

8"x10" x 1/8" tactile plate w/ raised Pictogram, Braille & Text: "EMERGENCY EXIT STAIRS"; Text Height: 5/8" H.
ROOM NUMBER to be included, as shown.

M 'IN CASE OF FIRE' - PICTOGRAM
8x10 - w/TACTILE & BRAILLE

SIGN TYPE M

8"x10" x 1/8" tactile plate w/ raised Pictogram, Braille & Text: "IN CASE OF FIRE DO NOT USE ELEVATOR USE STAIRS"; Text Height: 5/8" H.

N 'EXIT' PICTOGRAM
8x8 - w/TACTILE & BRAILLE

SIGN TYPE N

8"x8" x 1/8" tactile plate w/ raised Pictogram, Braille & Text: "EXIT"; Text Height: 3/8" H.

R3 'SHIP' OFFICE FLAG WAYFINDING SIGN
DBL Sided w/Ship 1" High Logo
10x6 w/WALL-MOUNTED BRACKET

SIGN TYPE R3

6"x9.5" W., Double-Sided Projecting Sign
w/silver bracket for mounting.
White text on Blue panel; Red vinyl accents;
Raised Logo detail applied as decal.

S 'SHIP' ENTRANCE SIGN 9x13
w/'SHIP' LOGO 3.75 High, TACTILE & BRAILLE

SIGN TYPE S

13"H.x9"W. tactile Entrance Sign
Pearl Gray backer & Marine Blue face panel
Raised Pearl Gray logo panel w/white vinyl decal applied
Printed with logo; Raised pearl gray text & Braille;
Red flat vinyl stripes. EXTERIOR DESIGN.

S 'SHIP' ENTRANCE SIGN 9x13
w/'SU' LOGO 3.75" High, TACTILE & BRAILLE

SIGN TYPE S

13"H.x9"W. tactile Entrance Sign
Pearl Gray backer & Marine Blue face panel
Raised Pearl Gray logo panel w/white vinyl decal applied
Printed with logo; Raised Red text & Braille;
Red flat vinyl stripes. EXTERIOR DESIGN.

SHIPPENSBURG UNIVERSITY
INTERIOR SIGN SPECIFICATIONS 2022

OFFICIAL LOGO SUBMISSION:
PRIOR APPROVALS ARE NEEDED TO USE UNIVERSITY OFFICIAL 'SHIP' OR 'SU' LOGOS. CONTACT UNIVERSITY COMMUNICATIONS & MARKETING DEPARTMENT - BRANDING DIVISION FOR APPROVALS.

SIGN DESIGN:
SIGNAGE STANDARDS (U.N.O.):
SHIPPENSBURG UNIVERSITY protocol for all Academic Buildings:
Back plate w/coordinating face plate design & radius corners;
Tactile Grade II, Raised 1/32"H. w/Braille Plate;
Font style: Helvetica-Medium; Text Height, min. 1/2" or as shown.
Sign color: CHARCOAL GRAY
Text color: BRIGHT WHITE

MOUNTING METHODS:
TYPICAL:
(3) continuous strips of double-sided tape applied to back.
ON BLOCK or BRICK: Use silicone with double-sided tape.
ON GLASS: Use clear double-sided tape for mounting.

SIGN INSTALLATION:
1- WIRE WALL SURFACE, FREE OF DIRT, DUST OR FILM ON WALL.
2- USE LEVEL TO PLACE SIGN STRAIGHT HORIZONTALLY.
3- PLACE CENTER OF SIGN @ 9" FROM FRAME (LATCH SIDE)
HORIZONTAL WITH THE TOP OF SIGN @ 60" AFF-VERTICALLY.
4- ALLOW 1/2" CLR SPACE BETWEEN SIGNS, VERT. & HORIZ.
(MAX-HEIGHT= 60" AND MIN-HEIGHT=48" ABOVE FLOOR).

TYPICAL SIGN PLATE & TEXT COLORS
STUDENT SERVICES: Silver #304 sign w/Blue #501 text.
ACADEMIC BUILDINGS: Charcoal Grey #307 sign w/Brilliant white #204 text.
RESIDENT HALLS: Silver #304 sign w/Blue #501 text.
BRANDING: Pearl Gray #306; Marine Blue #502; Red #601; White #204.

E6 'AUTHORIZED PERSONNEL ONLY'
12x12 - w/TACTILE & BRAILLE

SIGN TYPE E6

12"x12" x 1/8" tactile plate w/ raised text & Braille
Text: "message varies"; centered horizontally.
Text Height: varies; #Lines: varies.

APPENDIX 6 10440 INTERIOR SIGNAGE REQUIREMENTS

SHIPPENSBURG UNIVERSITY - 2022 Sign Package

<p>A ROOM NUMBER PLATE 4.5x3 - w/TACTILE & BRAILLE</p> <p>1J1 1EL1</p> <p>SIGN TYPE A</p>	<p>A1 SMALL 'EXIT' PLATE 4x4 - w/TACTILE & BRAILLE</p> <p>SIGN TYPE A1</p> <p>ELEVATOR ID NUMBER PLATE 4x4 - TACTILE NO.</p> <p>SIGN TYPE B</p>	<p>B CLASSROOM or OFFICE (2)-SLOT 6.5x6.5-1/2" INSERTS, TACTILE, BRAILLE & LOGO</p> <p>SIGN TYPE B SIGN TYPE B* (Includes 'Ship' Logo)</p>	<p>C OFFICE (4)-SLOT 8.5x6.5 - 1/2" INSERTS, TACTILE, BRAILLE & 1" High LOGO</p> <p>SIGN TYPE C SIGN TYPE C* (Includes 'Ship' Logo)</p>	<p>D 10"x10" MEDIUM DIRECTORY (6)-SLOT INSERTS w/TACTILE, BRAILLE & 1" High LOGO</p> <p>SIGN TYPE D SIGN TYPE D* (Includes 'Ship' Logo)</p>	<p>D1 12"x12" Overlay WAYFINDING DIRECTORY (8)-SLOTS Printed P/C Option</p> <p>SIGN TYPE D1 - Overlay SIGN TYPE D1* (Includes 'Ship' Logo)</p>	<p>E ROOM NUMBER PLATE 6.5x2.5 - w/TACTILE & BRAILLE</p> <p>SIGN TYPE E SIGN TYPE E* (Included 'Ship' Logo)</p>	<p>E1 ROOM NO. & NAME 8.5x2.5 - w/TACTILE & BRAILLE</p> <p>SIGN TYPE E1</p>	<p>E2 ROOM NAME & NO. PLATE (NARROW) 8.5x3.5 - w/TACTILE, BRAILLE</p> <p>SIGN TYPE E2</p>	<p>E3 ROOM NO. & NAME 8.5x4.5 - w/BRAILLE</p> <p>SIGN TYPE E3</p>
<p>E4 ROOM NO. & NAME 8.5x4.5 - w/BRAILLE ROOM NO.: (0.75") H. TACTILE ROOM NAME: (0.45") H. TACTILE</p> <p>SIGN TYPE E4 SIGN TYPE E4* (Includes 'Ship' Logo)</p>	<p>E5 EMERGENCY EXIT ONLY 8x6 - ISA TACTILE & BRAILLE</p> <p>SIGN TYPE E5</p>	<p>F WOMEN'S ADA RESTROOM PICTOGRAM w/ROOM NUMBER 8x6 - ISA TACTILE & BRAILLE</p> <p>SIGN TYPE F</p>	<p>F1 WOMEN'S ADA RESTROOM PICTOGRAM w/ROOM NUMBER 8x6 - ISA TACTILE & BRAILLE</p> <p>SIGN TYPE F1 Option w/Rm #</p>	<p>G MEN'S ADA RESTROOM PICTOGRAM w/ROOM NUMBER 8x6 - ISA TACTILE & BRAILLE</p> <p>SIGN TYPE G</p>	<p>G1 MEN'S ADA RESTROOM PICTOGRAM w/ROOM NUMBER 8x6 - ISA TACTILE & BRAILLE</p> <p>SIGN TYPE G1 Option w/Rm #</p>	<p>H UNISEX ADA RESTROOM PICTOGRAM w/ROOM NUMBER 8x6 - ISA TACTILE & BRAILLE</p> <p>SIGN TYPE H</p>	<p>H1 UNISEX ADA RESTROOM PICTOGRAM w/ROOM NUMBER 8x6 - ISA TACTILE & BRAILLE</p> <p>SIGN TYPE H1 Option w/Rm #</p>	<p>I Changeable INSERT FRAME (No Header) 11.5x9.5 - PAPER INSERT SLOT fits FULL-SHEET 11.5x3.5 - w/TACTILE & BRAILLE</p> <p>SIGN TYPE I</p>	<p>I1 Small DIRECTORY w/HEADER PAPER INSERT SLOT fits FULL-SHEET 11.5x3.5 - w/TACTILE & BRAILLE</p> <p>SIGN TYPE I-1</p>
<p>H2 UNISEX RESTROOM PICTOGRAM 8x6 - (NON-ADA) ISA TACTILE & BRAILLE</p> <p>SIGN TYPE H2</p>	<p>J AREA OF REFUGE - PICTOGRAM 8x6 - w/TACTILE & BRAILLE</p> <p>SIGN TYPE J</p>	<p>J1 AREA OF REFUGE - PICTOGRAM w/ARROWS 8x6 - w/TACTILE & BRAILLE</p> <p>TYPE J1-A TYPE J1-B</p> <p>SIGN TYPE J1-C</p>	<p>K ADA ACCESSIBLE 'EXIT' PICTOGRAM 8x6 - ISA TACTILE & BRAILLE</p> <p>SIGN TYPE K</p>	<p>K1-A ADA ACCESSIBLE PICTOGRAM EMERGENCY EXIT w/FUNCTIONAL ARROW 8x6 - ISA TACTILE & BRAILLE</p> <p>TYPE K1-A</p>	<p>L STAIRS PICTOGRAM 8x6 - ISA TACTILE & BRAILLE</p> <p>SIGN TYPE L</p>	<p>L1 STAIRS PICTOGRAM w/RM NO. 8x6 - w/TACTILE & BRAILLE</p> <p>SIGN TYPE L1 Option w/Rm #</p>	<p>L2 EM EXIT STAIRS PICTOGRAM w/ROOM NUMBER 8x6 - w/TACTILE & BRAILLE</p> <p>SIGN TYPE L2 Option w/Rm #</p>	<p>M IN CASE OF FIRE - PICTOGRAM 8x6 - w/TACTILE & BRAILLE</p> <p>SIGN TYPE M</p>	<p>N EXIT PICTOGRAM 8x6 - w/TACTILE & BRAILLE</p> <p>SIGN TYPE N</p>
<p>P ELEVATOR - PICTOGRAM 8x6 - w/TACTILE & BRAILLE</p> <p>SIGN TYPE P</p>	<p>Q-Q2 ADA ALL GENDER RESTROOM PICTOGRAM OPTIONS 8x6 - ISA TACTILE & BRAILLE</p> <p>SIGN TYPE Q</p> <p>SIGN TYPE Q1 SIGN TYPE Q2</p>	<p>R RESTROOMS Wall-Mounted FLAG Sign 12" x 4.5" x 1.8" w/ROOM NUMBER DOUBLE-SIDED Face Plates</p> <p>SIGN TYPE R</p>	<p>R1 UNISEX RESTROOM Wall-Mounted P/C Sign w/ROOM NUMBER 9.5x6x1/8" DOUBLE-SIDED Face Plates</p> <p>SIGN TYPE R1</p>	<p>R2 'SHIP' DEPT FLAG WAYFINDING SIGN 10.5" Sign w/SHIP Logo 4" High 9.75x10" WALL-MOUNTED BRACKET</p> <p>SIGN TYPE R2</p>	<p>R3 'SHIP' OFFICE FLAG WAYFINDING SIGN 10.5" Sign w/SHIP Logo 4" High 10x6" WALL-MOUNTED BRACKET</p> <p>SIGN TYPE R3</p>	<p>S 'SHIP' ENTRANCE SIGN 9x13 w/SHIP LOGO 3.75" High, TACTILE & BRAILLE</p> <p>SIGN TYPE S</p>	<p>S 'SHIP' ENTRANCE SIGN 9x13 w/SHIP LOGO 3.75" High, TACTILE & BRAILLE</p> <p>SIGN TYPE S</p>	<p>E6 'AUTHORIZED PERSONNEL ONLY' 12x12 - w/TACTILE & BRAILLE</p> <p>SIGN TYPE E6</p>	

A

ROOM NUMBER PLATE
4.5x3 – w/TACTILE & BRAILLE

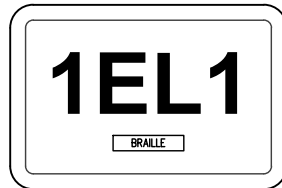
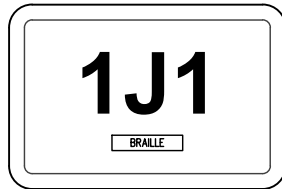
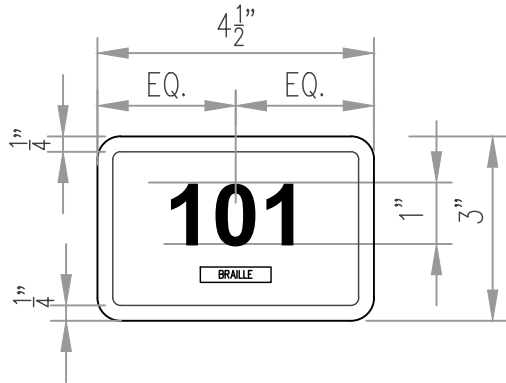

SIGN TYPE A

4.5"x3"x 1/8" backer plate (leaving 1/4" reveal)
4"x2.5"x1/16" face panel w/raised Text & Braille;
Text 1"H., Centered Horizontally.

A1

SMALL 'EXIT' PLATE 4x4 -
w/TACTILE & BRAILLE

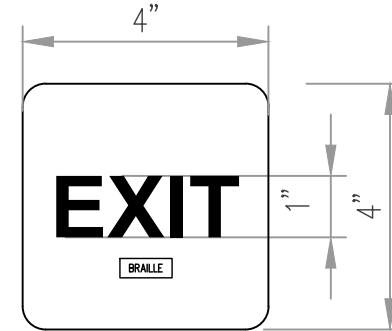

SIGN TYPE A1

4"x4"x 1/8" tactile sign w/ raised Text & Braille;
Text Height: 1" H., Centered Horizontally.

ELEVATOR ID NUMBER PLATE 4x4 - TACTILE NO.

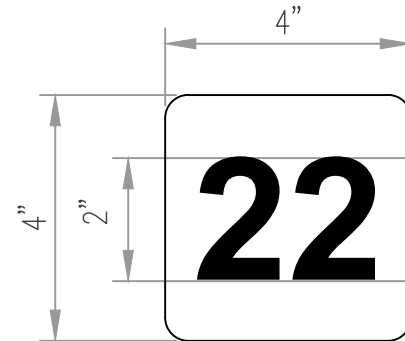

**ELEVATOR ID
NUMBER PLATE**

4"x4"x 1/8" acrylic plate w/ raised Text (No Braille);
Texted Height: 2"H., Centered Horizontally.

B**CLASSROOM or OFFICE (2)-SLOT**

6.5x6.5-1/2" INSERTS, TACTILE, BRAILLE & LOGO

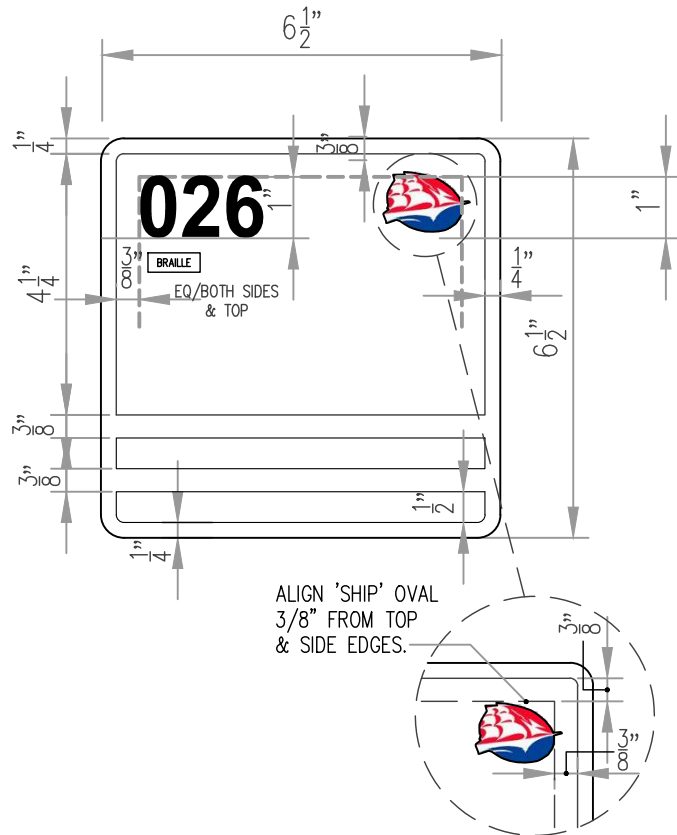
**SIGN TYPE B****SIGN TYPE B* (Includes 'Ship' Logo)**

6.5"x6.5" ADA sign x 1/8" acrylic backer (leaving 1/4" reveal)
 6"x4.25"x1/16" face panel w/raised Text & Braille and
 (2)-0.5"H x 6" W window slots at bottom;
 *Logo included @ top right corner.

C**OFFICE (4)-SLOT**

6.5x6.5 - 1/2" INSERTS, TACTILE, BRAILLE & 1" high LOGO

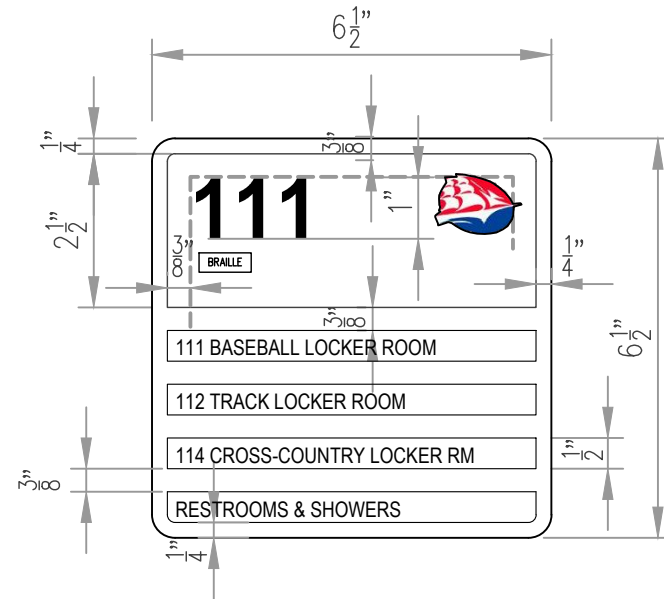
**SIGN TYPE C****SIGN TYPE C* (Includes 'Ship' Logo)**

6.5"x6.5" ADA sign x 1/8" acrylic backer (leaving 1/4" reveal)
 6"x4.25"x1/16" face panel w/raised Text & Braille and
 (4)-0.5"H x 6" W window slots at bottom;
 *Logo included @ top right corner.

D

**10"x10" MEDIUM DIRECTORY (6)-SLOT
INSERTS w/TACTILE, BRAILLE & 1" high LOGO**

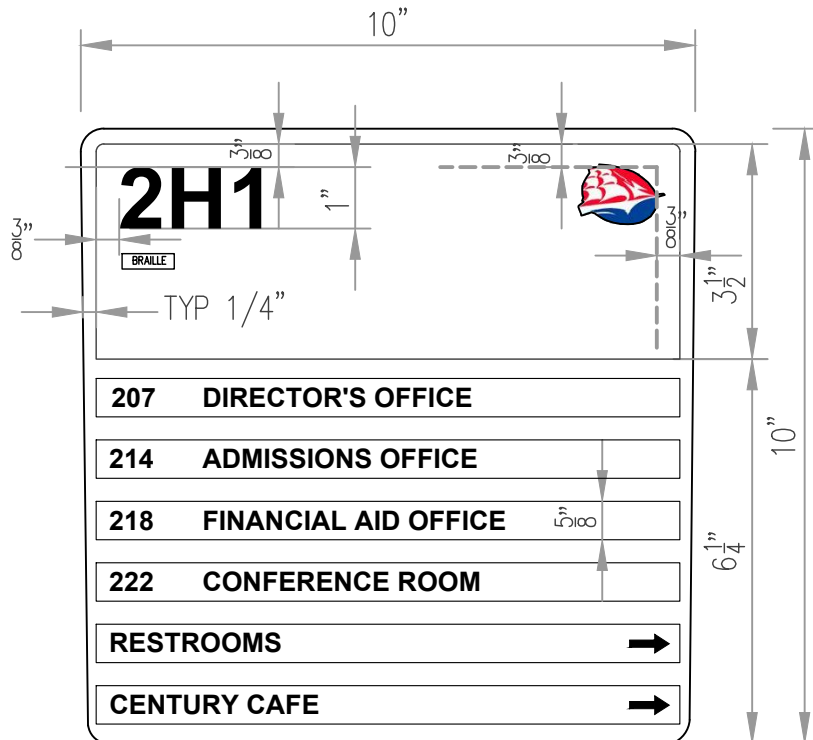
**SIGN TYPE D****SIGN TYPE D* (Includes 'Ship' Logo)**

10"x10"x1/8" tactile acrylic backer (leaving 1/4" reveal)
9.5"x3.5"x1/16" face panel w/raised Text & Braille and
(6)-0.5"H x 6"W window slots at bottom;
*Logo included @ top right corner.

D1

**12"x12" Over-lay WAYFINDING
DIRECTORY (8)-SLOTS
(Printed PVC Option)**

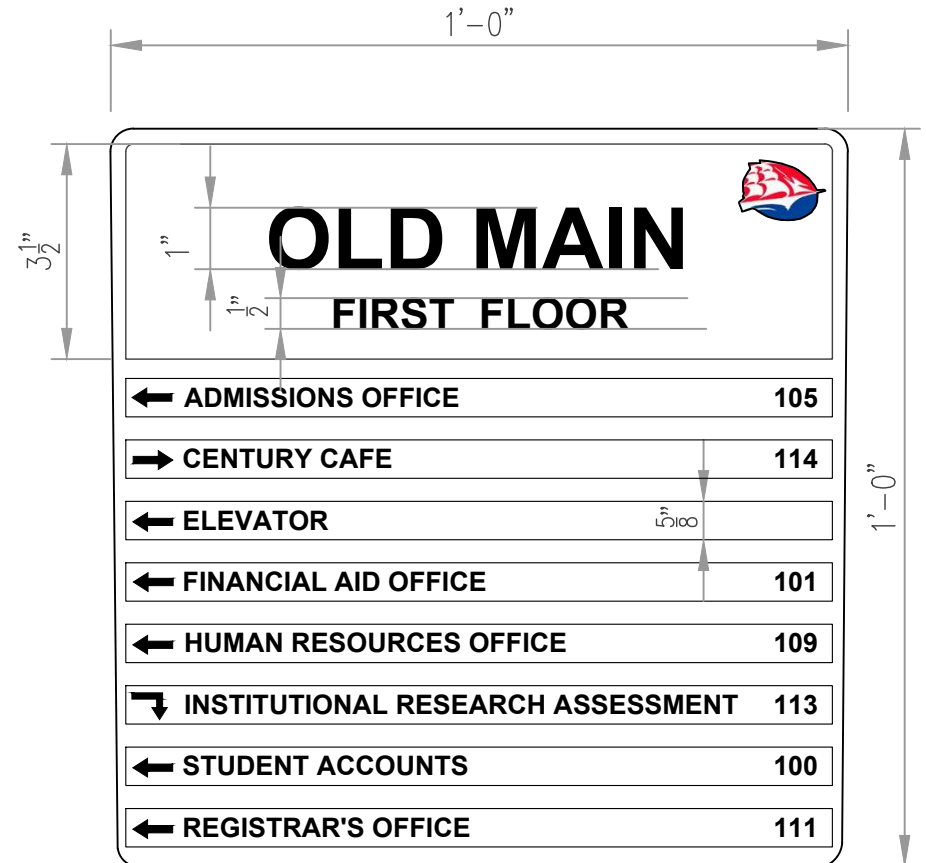
**SIGN TYPE D1 - Overlay****SIGN TYPE D1* (Includes 'Ship' Logo)**

WAYFINDING DIRECTORIES
12x12 (or 10x10) x 1/4" PVC Directory Sign
Printed as a decal applied to face of black panel.

E

ROOM NUMBER PLATE
6.5x2.5 – w/TACTILE & BRAILLE

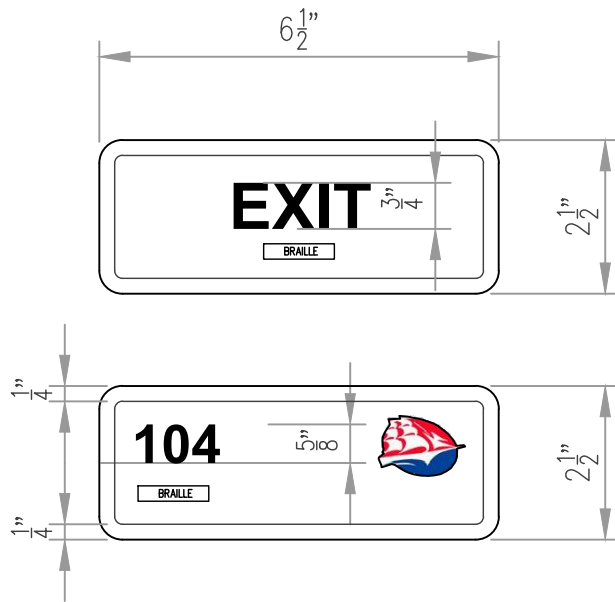

SIGN TYPE E

SIGN TYPE E* (Included 'Ship' Logo)

6.5"x2.5"x 1/8" backer plate (leaving 1/4" reveal)
6"x2"x1/16" face panel w'/raised Text & Braille;
Text height & location varies; Logo optional.

E1

ROOM NO. & NAME
8.5x2.5 – w/TACTILE & BRAILLE

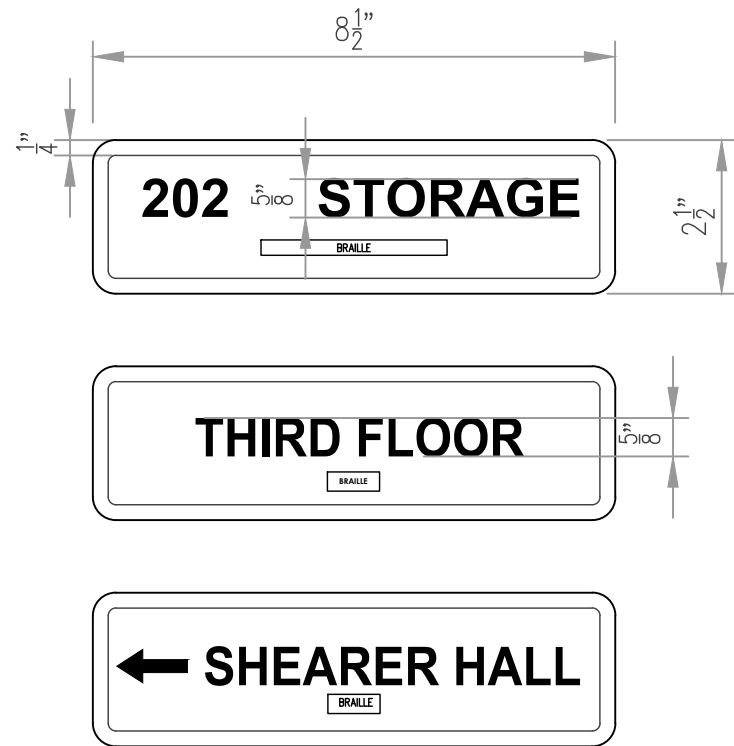

SIGN TYPE E1

8.5"x2.5"x 1/8" backer plate (leaving 1/4" reveal)
8"x2"x1/16" face panel w'/raised Text & Braille;
Room Number 5/8" H., Left justified.
Room Name (same row) 5/8" H., Right justified.
Or Text 5/8"H., Centered Horizontally.

E2 ROOM NAME & NO. PLATE (w/ARROW)

8.5x3.5 – w/TACTILE, BRAILLE

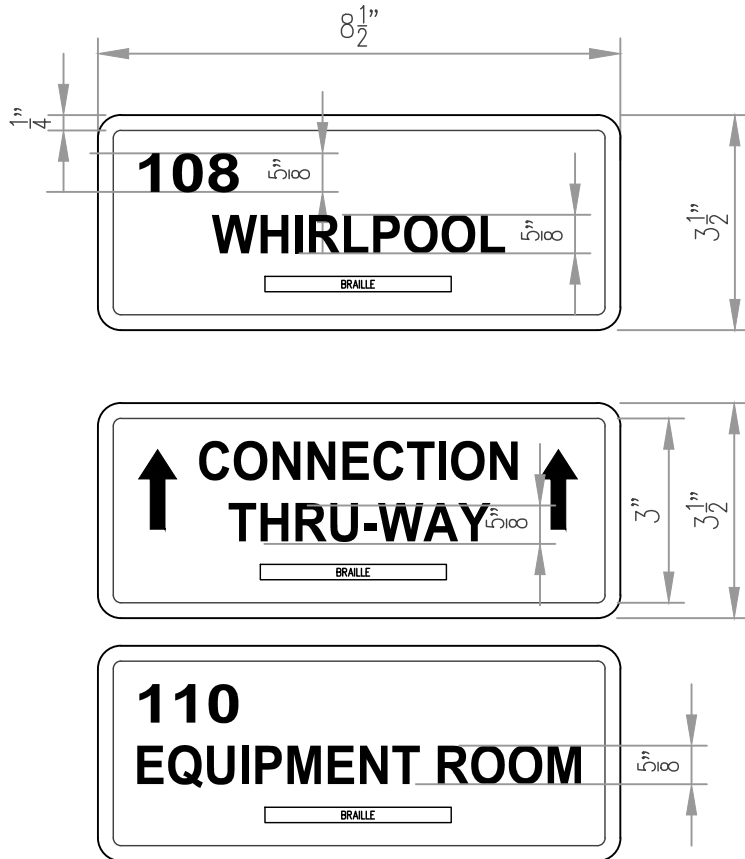

SIGN TYPE E2

8.5"x3.5"x 1/8" backer plate (leaving 1/4" reveal)
8"x3"x1/16" face panel w/raised Text, Arrows & Braille;
Room Number 5/8" H., Top left justified.
Room Name 5/8" H., Center justified.
(Or 2 rows 5/8" H., each) as shown.

E3

ROOM NO. & NAME:

8.5x4.5 – w/BRAILLE

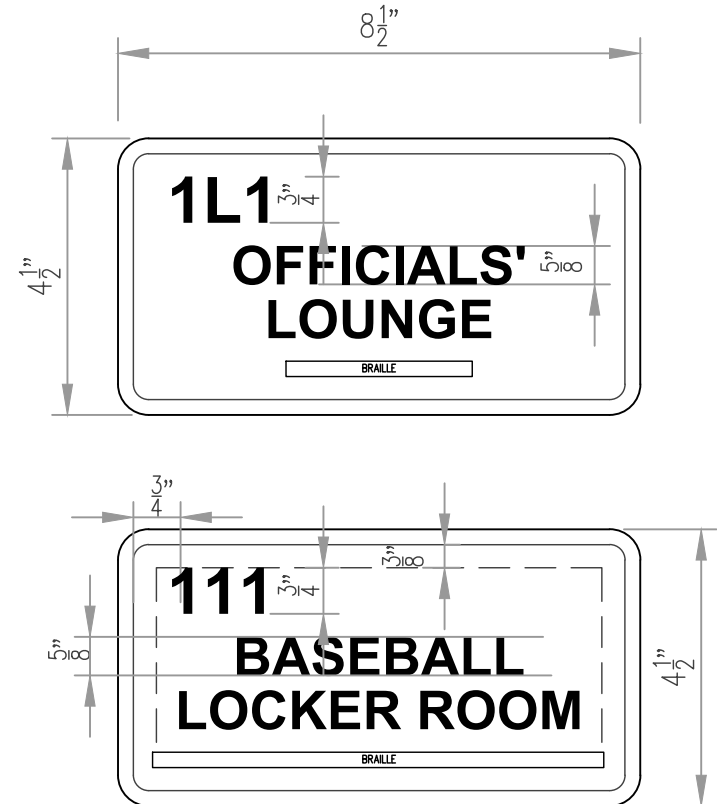

SIGN TYPE E3

8.5"x4.5"x 1/8" backer plate (leaving 1/4" reveal)
8"x4"x1/16" face panel w/raised Text, Arrows & Braille;
Room Number 3/4" H., Top left justified.
Room Name (rows 2 & 3) 5/8" H., Center justified.
Or all (3 rows) 5/8" H., as shown.

E4

ROOM NO. & NAME:

8.5x5.5 – w/BRAILLE

ROOM NO.: (0.75") H. TACTILE

ROOM NAME: (0.625") H. TACTILE

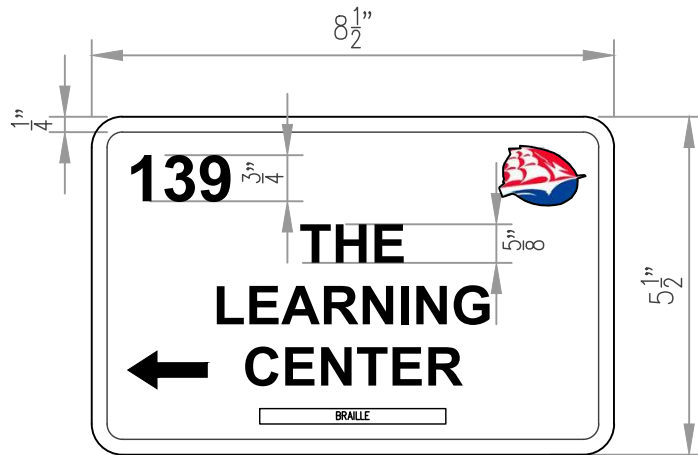

SIGN TYPE E4

SIGN TYPE E4* (Includes 'Ship' Logo)

8.5"x5.5"x 1/8" backer plate (leaving 1/4" reveal)
 8"x5"x1/16" face panel w/raised Text, Arrows & Braille;
 Room Number 3/4" H., Top left justified.
 Room Name 5/8" H., Center justified.
 *Logo included @ top right corner.

E5

'EMERGENCY EXIT ONLY'

8x8 – ISA TACTILE & BRAILLE

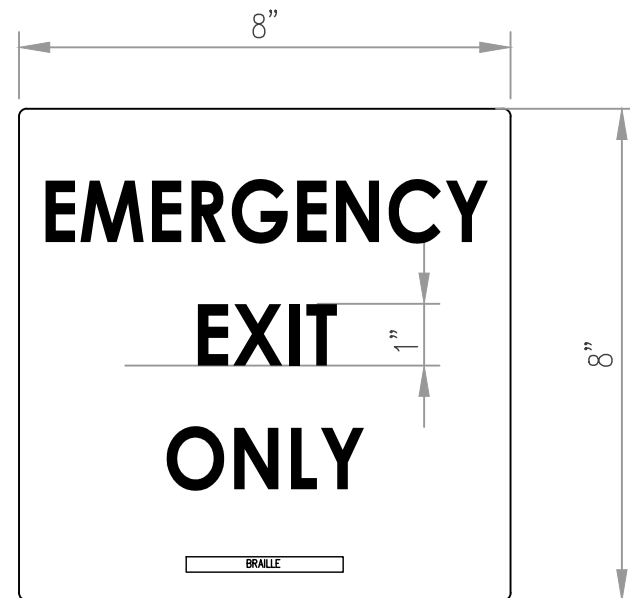

SIGN TYPE E5

8"x8"x1/8" tactile plate w/ raised text & Braille
 Text: "EMERGENCY EXIT ONLY" centered horizontally.
 Text Height: (3)-Lines @ 1" H.; (4)-Lines @ 3/4" H.

E6

'AUTHORIZED PERSONNEL ONLY'

12x12 – w/TACTILE & BRAILLE



SIGN TYPE E6

12"x12"x1/8" tactile plate w/ raised text & Braille
Text: "(message varies)" centered horizontally.
Text Height: varies; #-Lines: varies.

E6

'NO UN AUTHORIZED PERSONNEL'

10x10 – w/TACTILE & BRAILLE

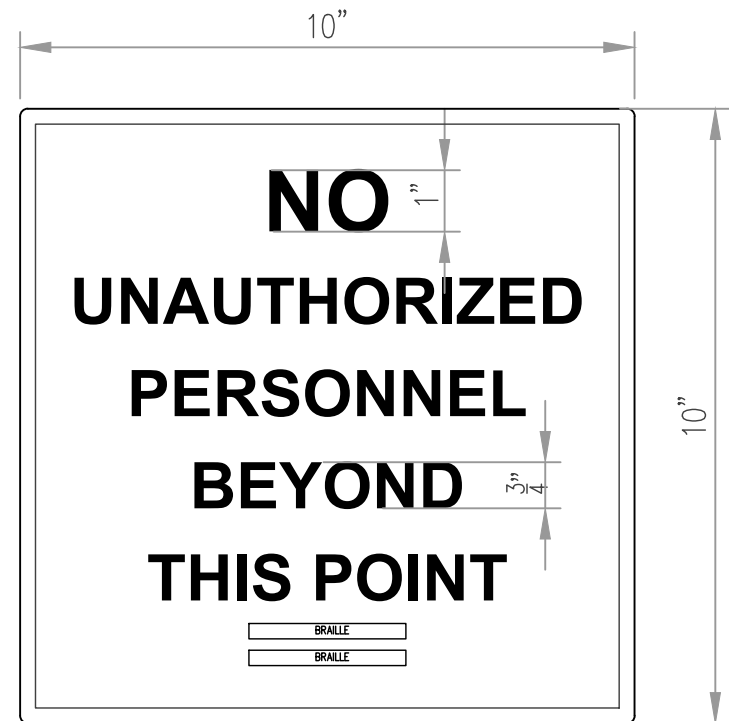

SIGN TYPE E6

10"x10"x1/8" tactile plate w/ raised text & Braille
Text: "(message varies)" centered horizontally.
Text Height: varies; #-Lines: varies.

F

WOMEN'S ADA RESTROOM PICTOGRAM
w/ROOM NUMBER

8x8 – ISA TACTILE & BRAILLE

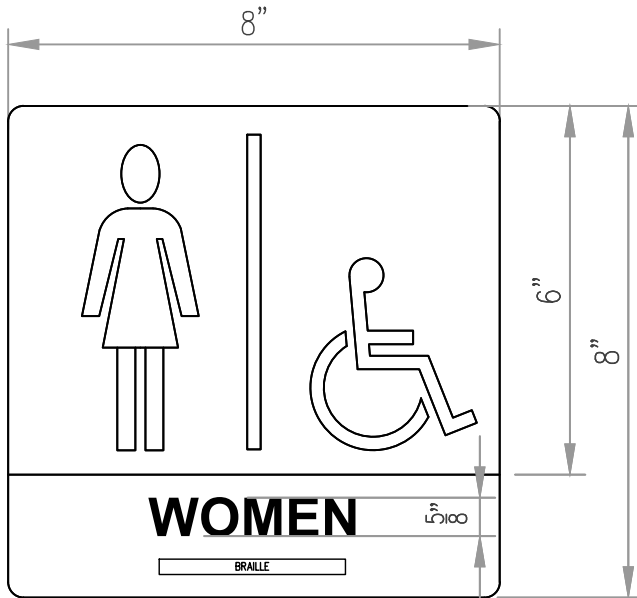

SIGN TYPE F

8"x8"x1/8" tactile plate w/ raised Pictogram, Braille &
Text: "WOMEN"; Text Height: 5/8" H.

F1

WOMEN'S ADA RESTROOM PICTOGRAM
w/ROOM NUMBER

8x9 – ISA TACTILE & BRAILLE

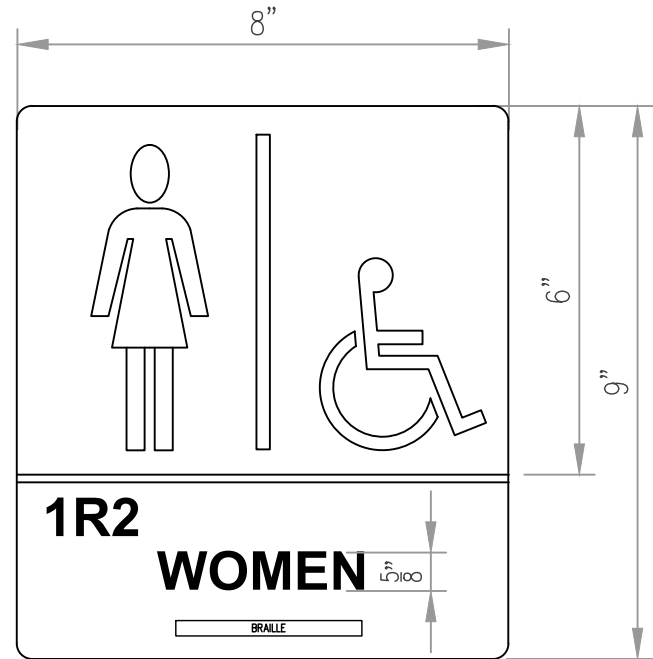

SIGN TYPE F1

Option w/Rm #

8"x9"x1/8" tactile plate w/ raised Pictogram, Braille &
Text: "WOMEN"; Text Height: 5/8" H.
ROOM NUMBER to be included, as shown.

G

MEN'S ADA RESTROOM PICTOGRAM

8x8 – ISA TACTILE & BRAILLE

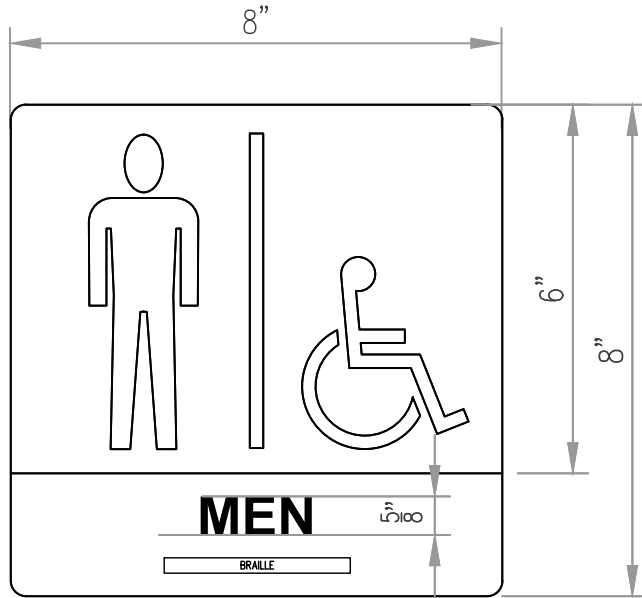

SIGN TYPE G

8"x8"x1/8" tactile plate w/ raised Pictogram, Braille & Text: "MEN"; Text Height: 5/8" H.

G1

MEN'S ADA RESTROOM PICTOGRAM

w/ROOM NUMBER

8x9 – ISA TACTILE & BRAILLE

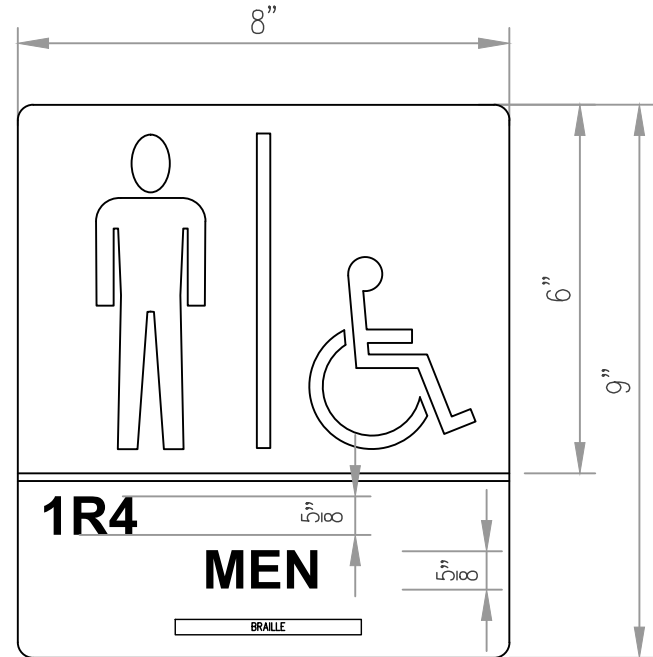

SIGN TYPE G1

Option w/Rm #

8"x9"x1/8" tactile plate w/ raised Pictogram, Braille & Text: "MEN"; Text Height: 5/8" H. ROOM NUMBER to be included, as shown.

H

UNISEX ADA 'RESTROOM' PICTOGRAM

8x8 – ISA TACTILE & BRAILLE

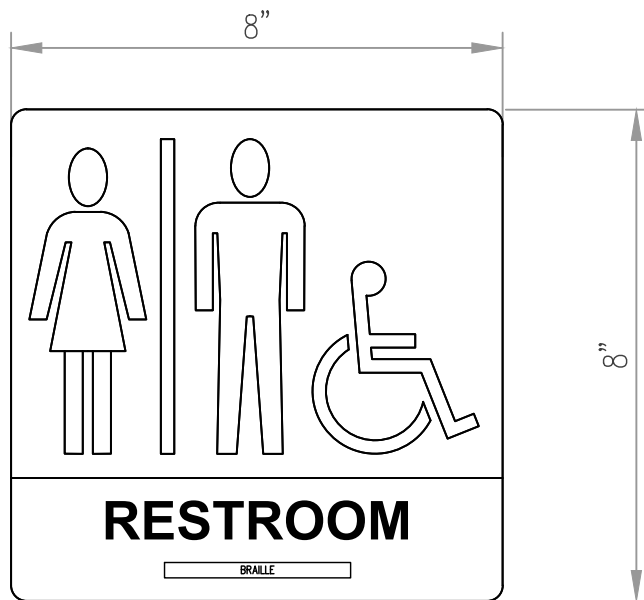

SIGN TYPE H

8"x8"x1/8" tactile plate w/ raised Pictogram, Braille & Text: "RESTROOM"; Text Height: 5/8" H.

H1

UNISEX ADA 'RESTROOM' PICTOGRAM

w/ROOM NUMBER

8x9 – ISA TACTILE & BRAILLE

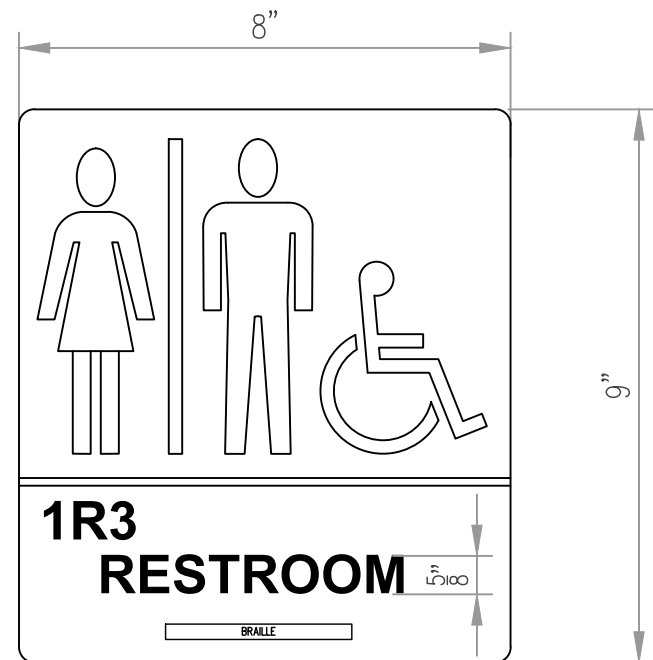

SIGN TYPE H1

Option w/Rm #

8"x9"x1/8" tactile plate w/ raised Pictogram, Braille & Text: "RESTROOM"; Text Height: 5/8" H. ROOM NUMBER to be included, as shown.

H2

UNISEX RESTROOM PICTOGRAM

8x8 – (NON-ADA) ISA TACTILE & BRAILLE

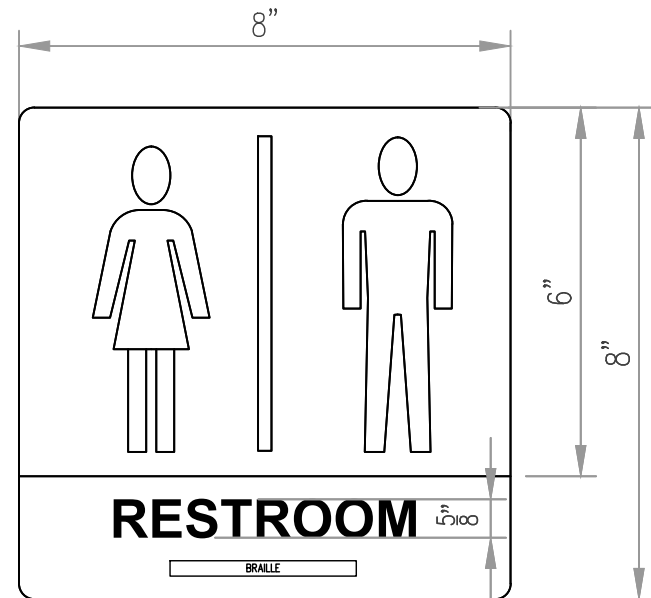

SIGN TYPE H2

8"x8"x1/8" tactile plate w/ raised Pictogram, Braille & Text: "RESTROOM"; Text Height: 5/8" H.

I

Changeable INSERT FRAME (No Header)

11.5x9.5 – PAPER INSERT SLOT fits FULL-SHEET

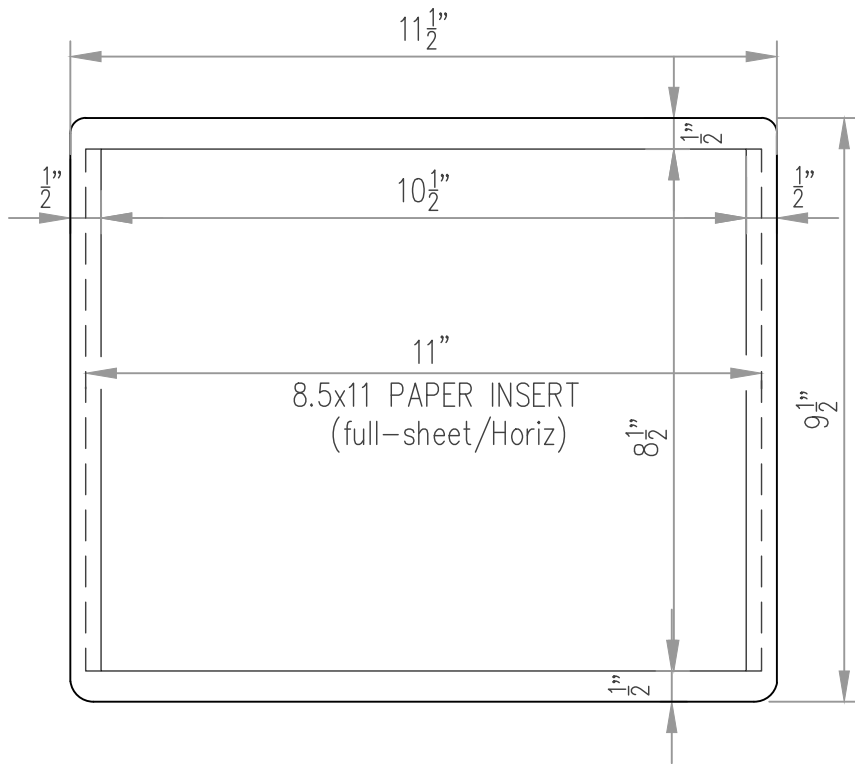

SIGN TYPE I

9.5"H.x11.5"W.x1/8" acrylic sign w/FULL INSERT
LARGE Window Slot to fit 8.5"x11" sheet.

I1

Changeable Message Frame Small DIRECTORY w/HEADER

PAPER INSERT SLOT fits FULL-SHEET
11.5x13 – w/TACTILE & BRAILLE

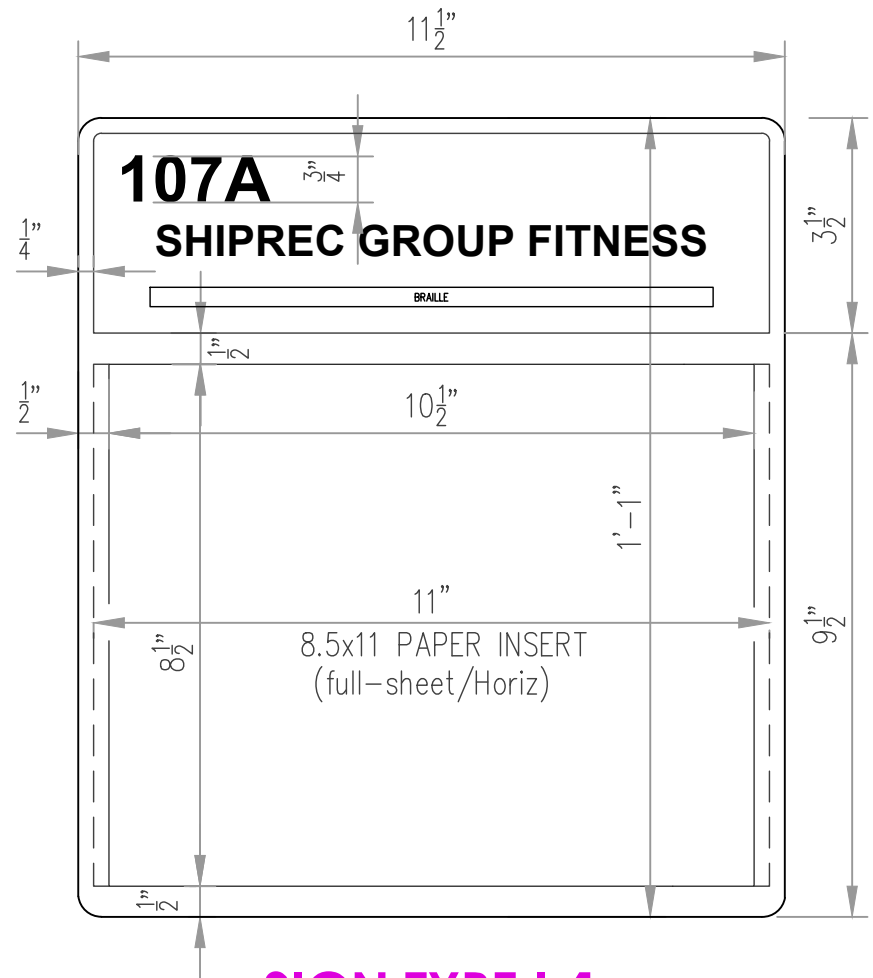

SIGN TYPE I-1

13"x11.5"x1/8" acrylic backer w/FULL INSERT & header
3.25"x11"x1/16" face panel w/raised text & Braille.
LARGE Window Slot to fit 8.5"x11" sheet.

12

**Changeable Message Frame
LG DIRECTORY w/HEADER & LOGO**

9x16 – w/TACTILE & BRAILLE; PAPER INSERT SLOT
9"

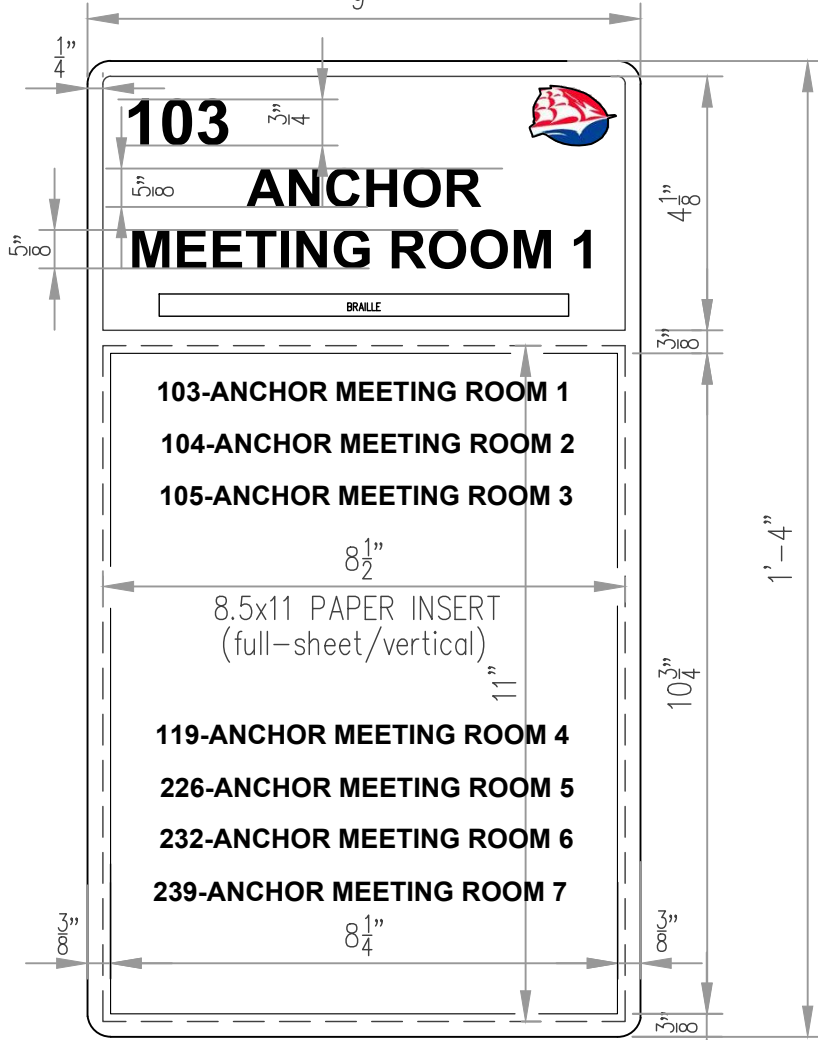

SIGN TYPE I-2

SIGN TYPE I-2* (Includes 'Ship' Logo)

17.25"x9"x1/8" acrylic backer w/FULL INSERT & header
5"x8.5"x1/16" face panel w/raised text & Braille.
LARGE Window Slot to fit 8.5"x11" sheet; Logo top rt.

13

**Changeable Message Frame
Small DIRECTORY w/HEADER**

PAPER INSERT SLOT fits HALF-SHEET
11.5x13 – w/TACTILE & BRAILLE

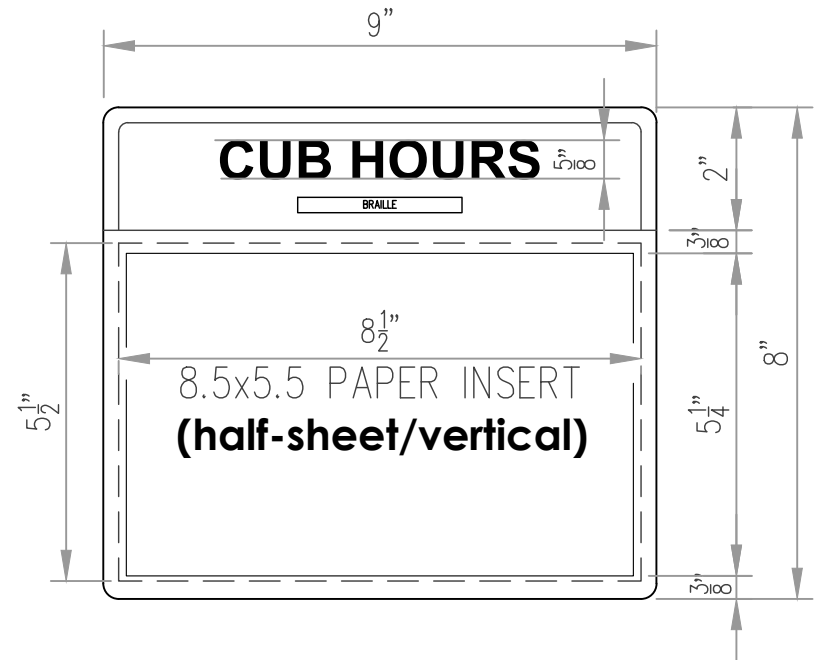

SIGN TYPE I-3 (half-sheet insert)

9"x8"x1/8" tactile acrylic backer (leaving 1/4" reveal)
8.5"x2"x1/16" face panel w/ 5/8"H. raised Text & Braille;
(1)-5.5"H x 8.5"W half-sht window slot.

J

'AREA OF REFUGE' - PICTOGRAM

8x9 – w/TACTILE & BRAILLE

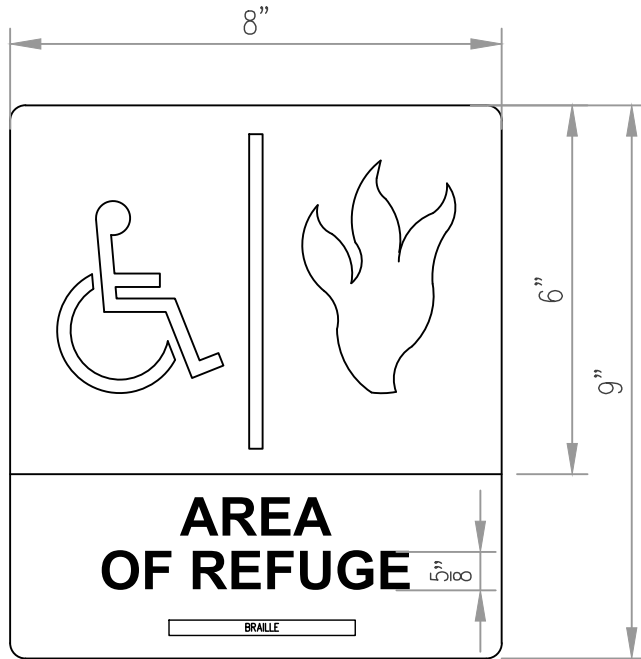

SIGN TYPE J

8"x9"x1/8" tactile plate w/ raised Pictogram, Braille & Text: "AREA OF REFUGE"; Text Height: 5/8" H.

J1

'AREA OF REFUGE' - PICTOGRAM

w/ARROWS

8x9 – w/TACTILE & BRAILLE

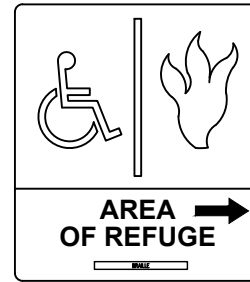

TYPE J1-A



TYPE J1-B

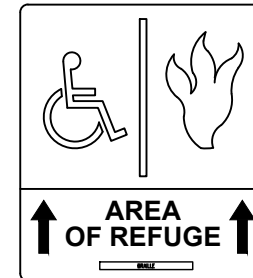

SIGN TYPE J1-C

8"x9"x1/8" tactile plate w/ raised Pictogram, Braille & Text: "AREA OF REFUGE" w/Arrows; Text Height: 5/8" H.

K

ADA ACCESSIBLE 'EXIT' PICTOGRAM

8x8 – ISA TACTILE & BRAILLE

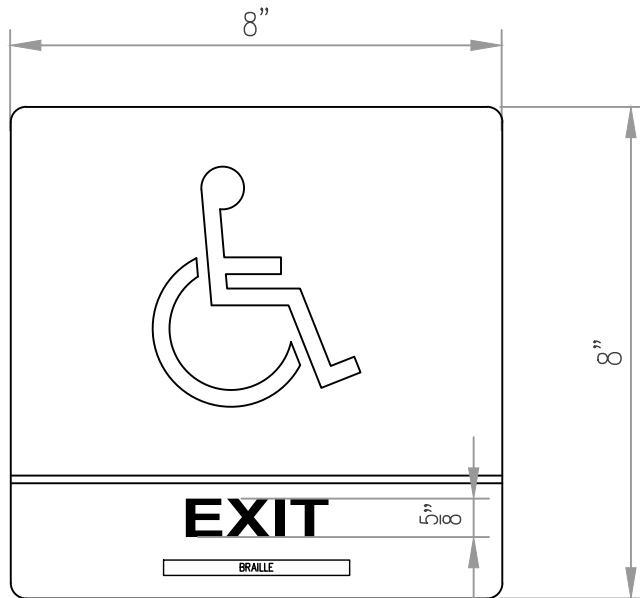

SIGN TYPE K

8"x8"x1/8" tactile plate w/ raised Pictogram, Braille & Text: "EXIT"; Text Height: 5/8" H.

K1-A

ADA ACCESSIBLE PICTOGRAM

'EMERGENCY EXIT'

w/DIRECTIONAL ARROW

8x9 – ISA TACTILE & BRAILLE

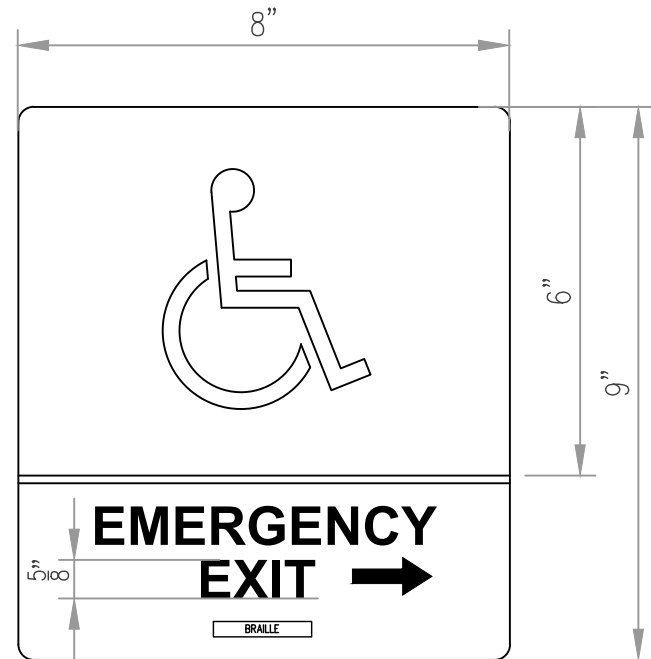

TYPE K1-A

8"x9"x1/8" tactile plate w/ raised Pictogram, Braille & Text: "EMERGENCY EXIT" w/Arrow; Text Height: 5/8" H.

L

'STAIRS' PICTOGRAM

8x8 – w/TACTILE & BRAILLE

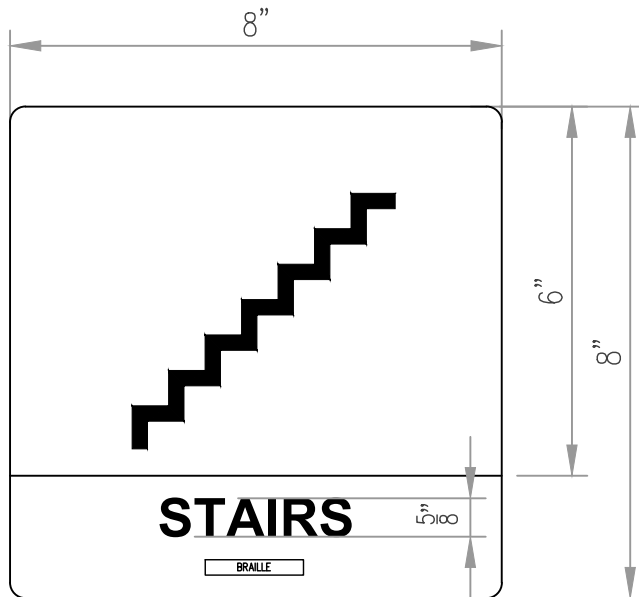

SIGN TYPE L

8"x8"x1/8" tactile plate w/ raised Pictogram, Braille & Text: "STAIRS"; Text Height: 5/8" H.

L1

'STAIRS' PICTOGRAM w/RM NO.

8x9 – w/TACTILE & BRAILLE

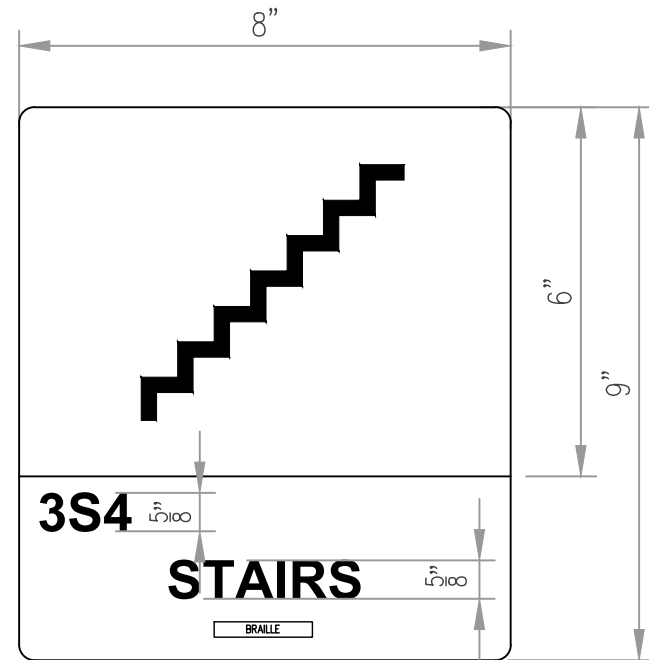

SIGN TYPE L1

Option w/Rm #

8"x9"x1/8" tactile plate w/ raised Pictogram, Braille & Text: "STAIRS"; Text Height: 5/8" H.
ROOM NUMBER to be included, as shown.

L2

**'EM EXIT STAIRS' PICTOGRAM
w/ROOM NUMBER**

8x10 – w/TACTILE & BRAILLE

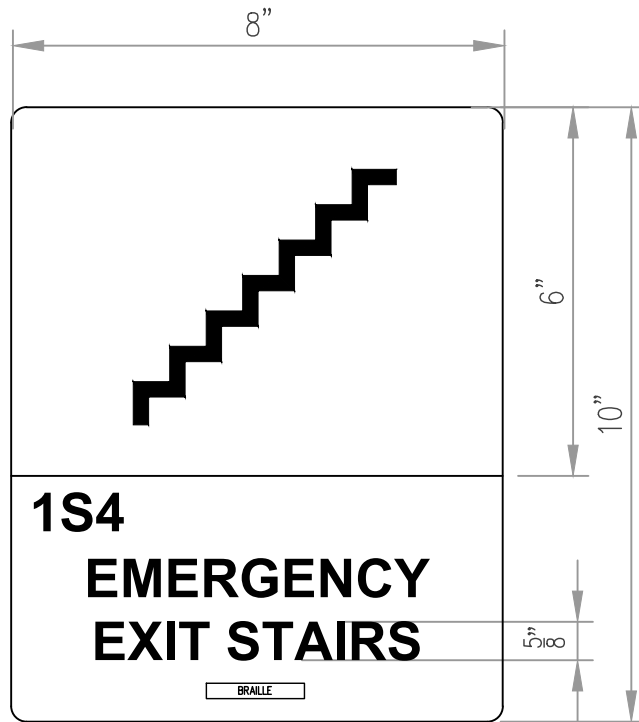

SIGN TYPE L2

Option w/Rm #

8"x10"x1/8" tactile plate w/ raised Pictogram, Braille &
Text: "EMERGENCY EXIT STAIRS"; Text Height: 5/8" H.
ROOM NUMBER to be included, as shown.

M

'IN CASE OF FIRE' - PICTOGRAM

8x10 – w/TACTILE & BRAILLE



SIGN TYPE M

8"x10"x1/8" tactile plate w/ raised Pictogram, Braille &
Text: "IN CASE OF FIRE DO....."; Text Height: 5/8" H.

N

'EXIT' PICTOGRAM

8x8 – w/TACTILE & BRAILLE

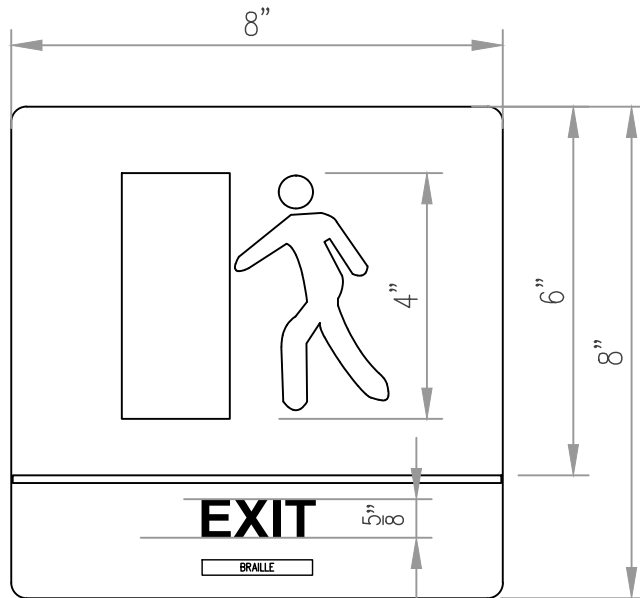

SIGN TYPE N

8"x8"x1/8" tactile plate w/ raised Pictogram, Braille & Text: "EXIT"; Text Height: 5/8" H.

P

'ELEVATOR' - PICTOGRAM

8x8 – w/TACTILE & BRAILLE

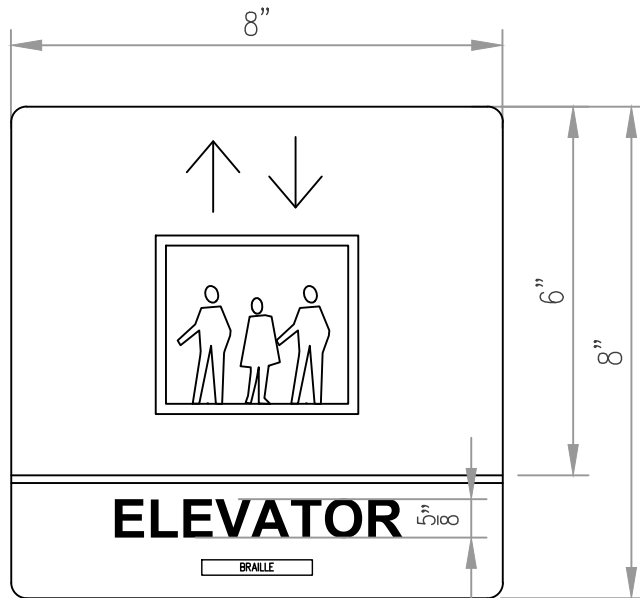

SIGN TYPE P

8"x8"x1/8" tactile plate w/ raised Pictogram, Braille & Text: "ELEVATOR"; Text Height: 5/8" H.

Q-Q2 ADA 'ALL GENDER RESTROOM'
PICTOGRAM - OPTIONS

8x9 – ISA TACTILE & BRAILLE



SIGN TYPE Q



SIGN TYPE Q1



SIGN TYPE Q2

8"x9"x1/8" tactile plate w/ raised Pictogram, Braille & Text: " (varies)"; Text Height: 5/8" H.

R

**'RESTROOMS' Wall-Mounted
FLAG Sign (12 x 4.5 x 1/8") w/ARROW**
DOUBLE-SIDED Face Plates

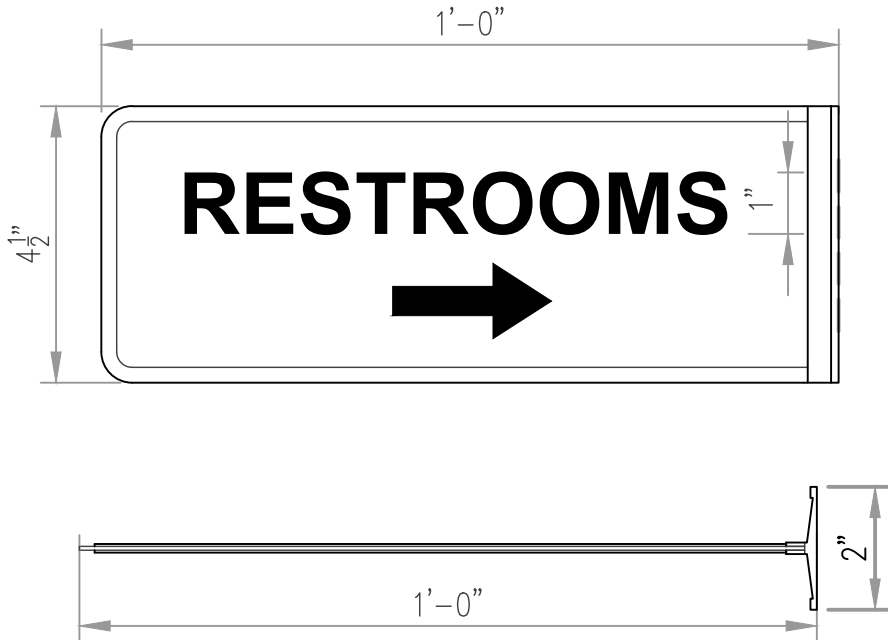
**SIGN TYPE R**

FLANGE MOUNT SIGN- Double-sided
4.5"x12"x1/8" acrylic backer (leaving 1/4" reveal)
4"x11.25x1/16" face panel on BOTH SIDES
w/ raised Text & Arrow (no Braille)
with black flange bracket for mounting to wall.

R1

**UNISEX 'RESTROOM' Wall-Mounted
FLAG Sign w/ARROW**
9.5x9x1/8" DOUBLE-SIDED Face Plates

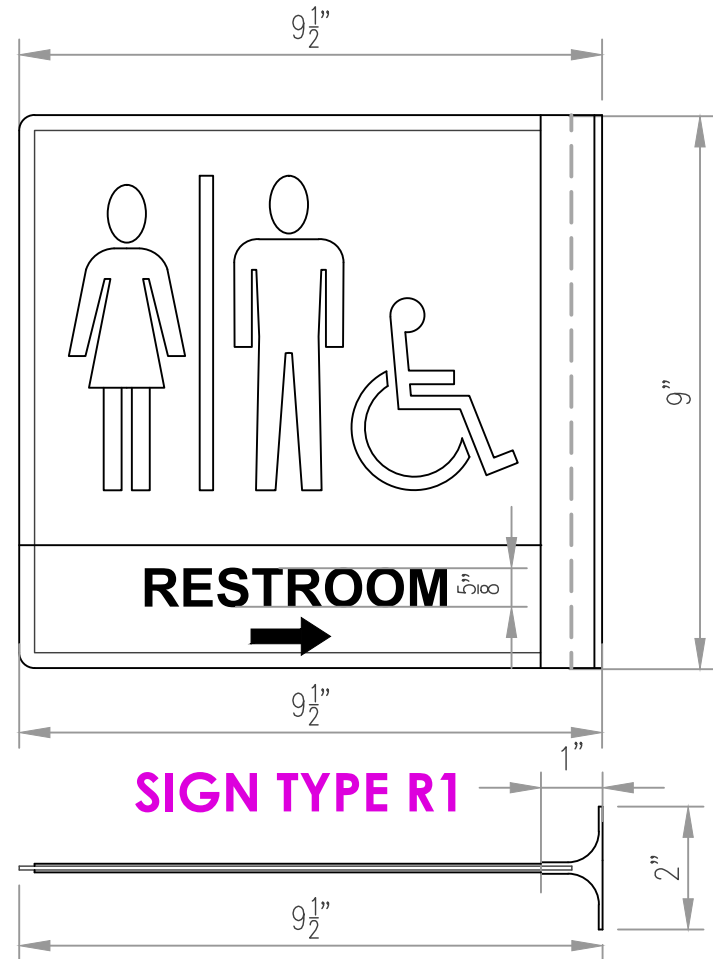
**SIGN TYPE R1**

FLANGE MOUNT SIGN- Double-sided
9"x9.5"x1/8" acrylic backer (leaving 1/4" reveal)
8.5"x8.75x1/16" face panel on BOTH SIDES
w/ raised Pictogram & Text (no Braille)
with black flange bracket for mounting to wall.

R2

'SHIP' DEPT FLAG WAYFINDING SIGN
DBL-Sided w/'Ship' Logo +2" high
9.75x10 w/WALL-MOUNTED BRACKET



SIGN TYPE R2

10"x9.75"W. Double-Sided Projecting Sign
w/silver bracket for mounting,
White text on Blue panel; Red vinyl accents;
Pearl Gray backer piece w/raised 3-color logo shape at top.
Logo detail applied as decal.

R3

'SHIP' OFFICE FLAG WAYFINDING SIGN
DBL Sided w/'Ship' 1" high Logo
10x6 w/WALL-MOUNTED BRACKET

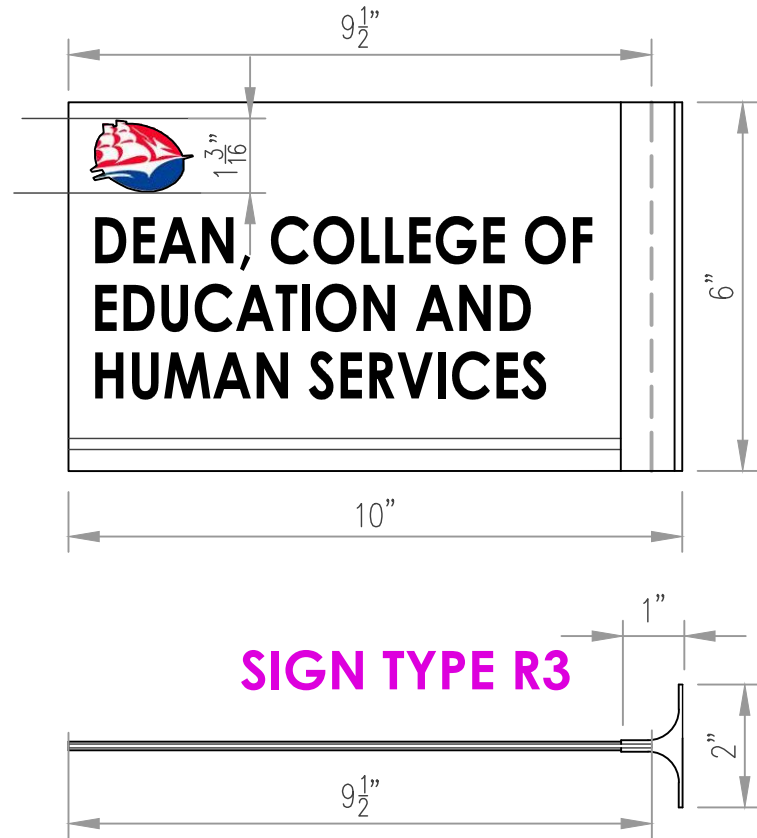

SIGN TYPE R3

6"x9.5"W. Double-Sided Projecting Sign
w/silver bracket for mounting,
White text on Blue panel; Red vinyl accents;
Raised Logo detail applied as decal.

S**'SHIP' ENTRANCE SIGN 9x13**

w/'SHIP' LOGO 3.75 High, TACTILE & BRAILLE

**SIGN TYPE S**

13"H.x9"W. tactile Entrance Sign

Pearl Gray backer & Marine blue face panel
 Raised Pearl Gray logo panel w/white vinyl decal applied
 Printed with logo; Raised pearl gray text & Braille;
 Red flat vinyl stripes. EXTERIOR DESIGN.

S**'SHIP' ENTRANCE SIGN 9x13**

w/'SU' LOGO 3.75" High, TACTILE & BRAILLE

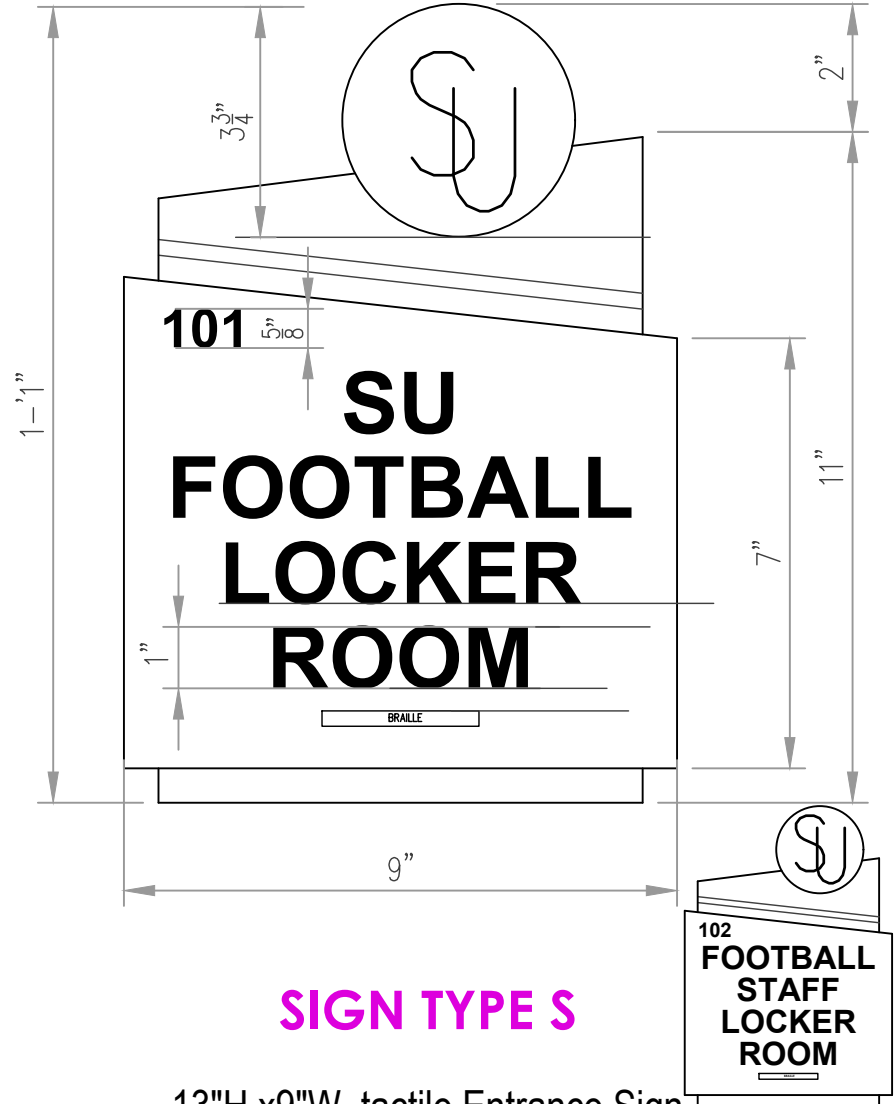
**SIGN TYPE S**

13"H.x9"W. tactile Entrance Sign

Pearl Gray backer & Marine Blue face panel
 Raised Pearl Gray logo panel w/white vinyl decal applied
 Printed with logo; Raised Red text & Braille;
 Red flat vinyl stripes. EXTERIOR DESIGN.